

**DUO 86**

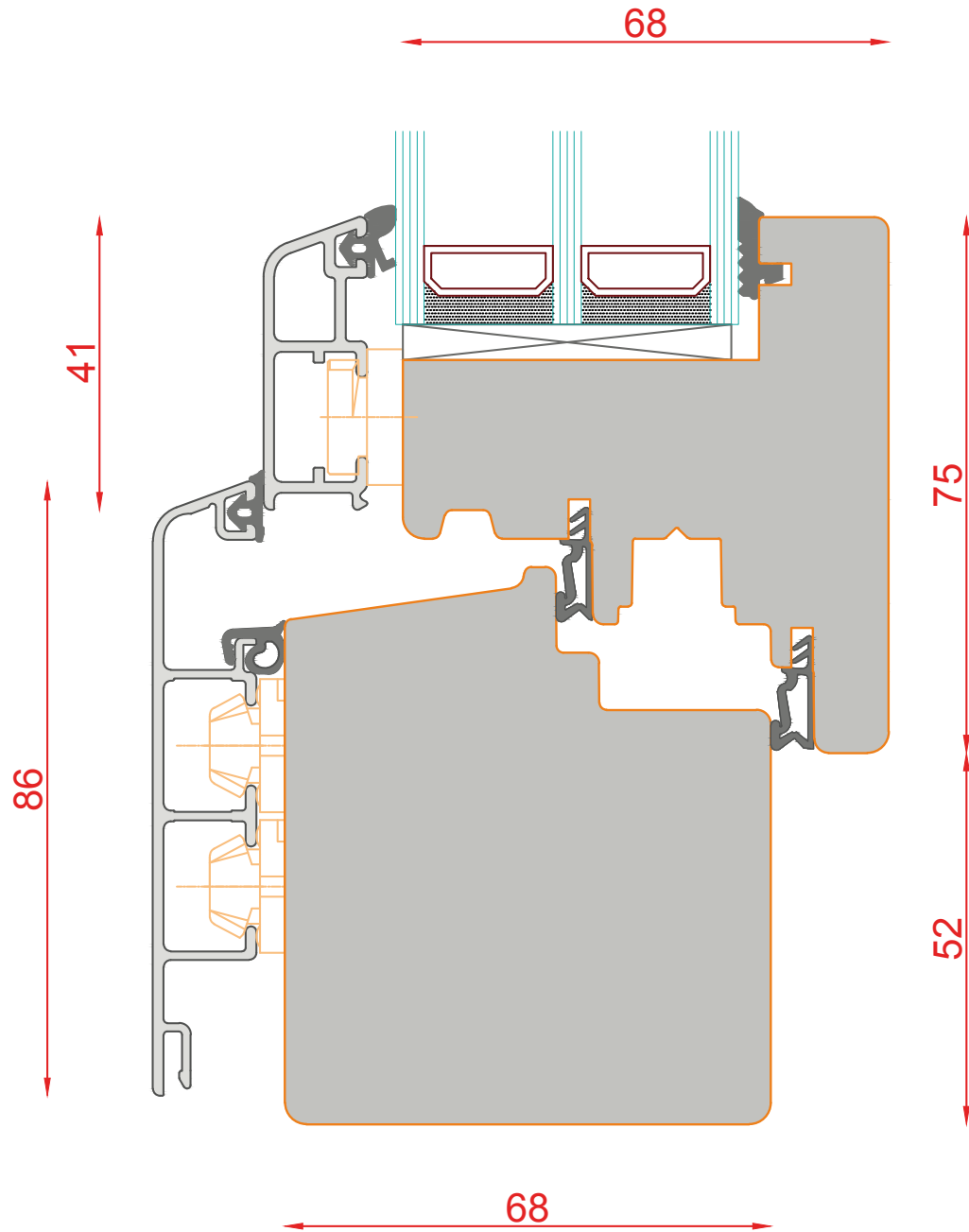
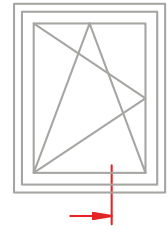

DUO 86

Schnitt : Vertikal unten

Typ: DK

| Seite: 109



**SCHMIDT VISBEK**  
Fenster. Türen. Innenelemente.

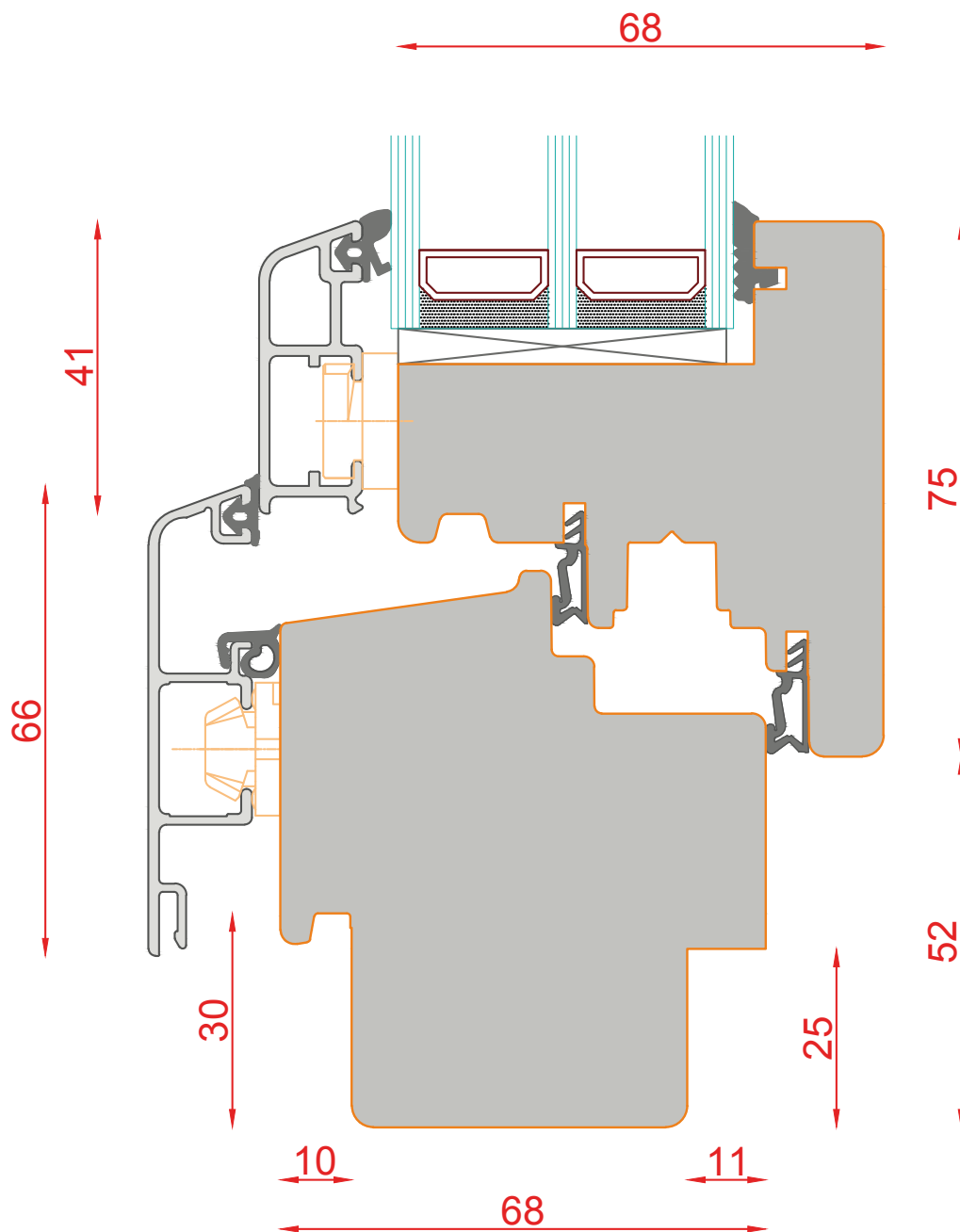
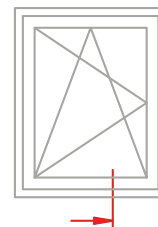

DUO 86

Schnitt : Vertikal unten

Typ: DK mit Fensterbankfalz | Seite: 110

**SCHMIDT VISBEK**  
Fenster · Türen · Innenelemente



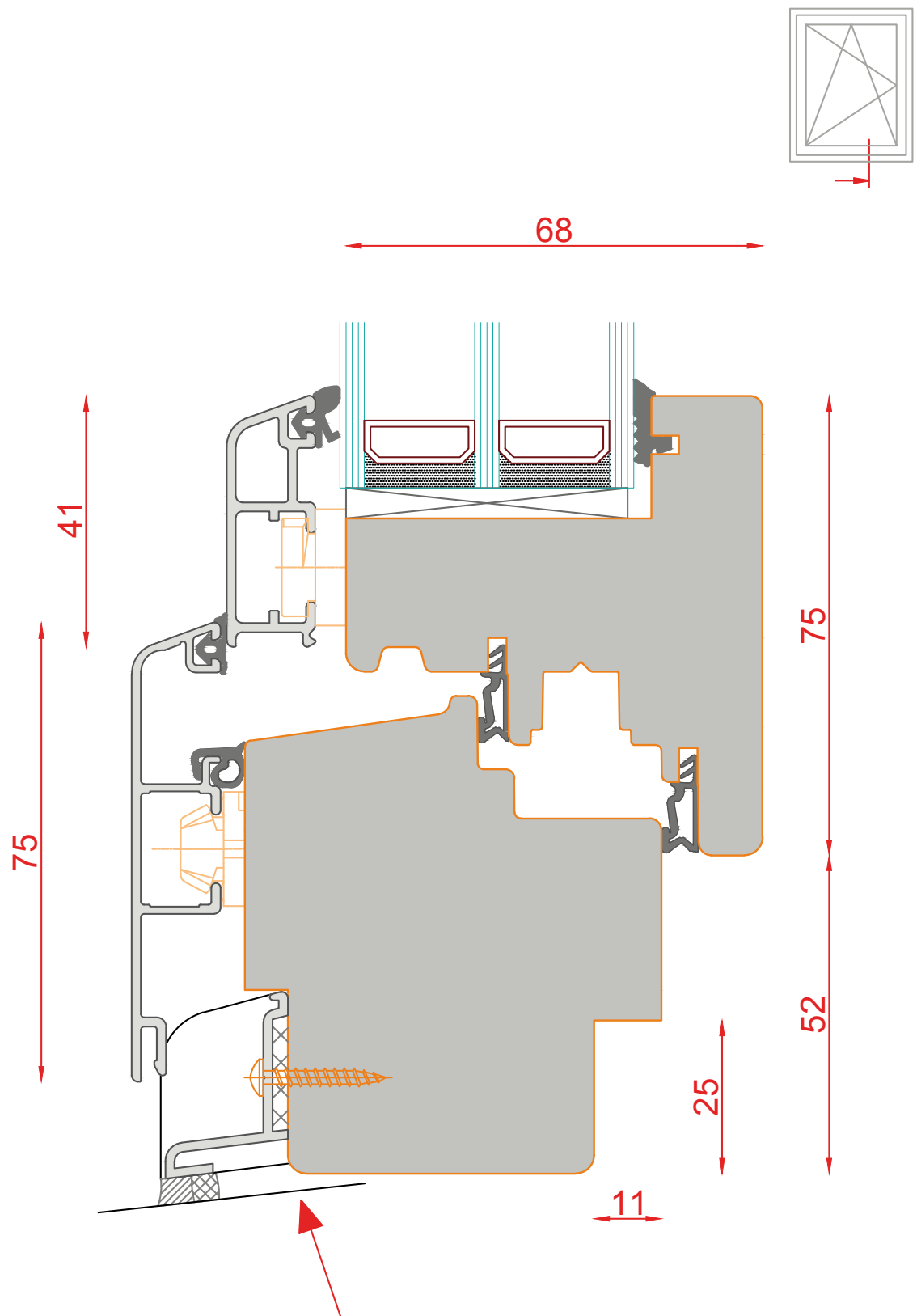

**Befestigung Steinbankanschluss optional:**

- Sichtbar mit Schraube
- oder angeklebt
- mit Endkappen



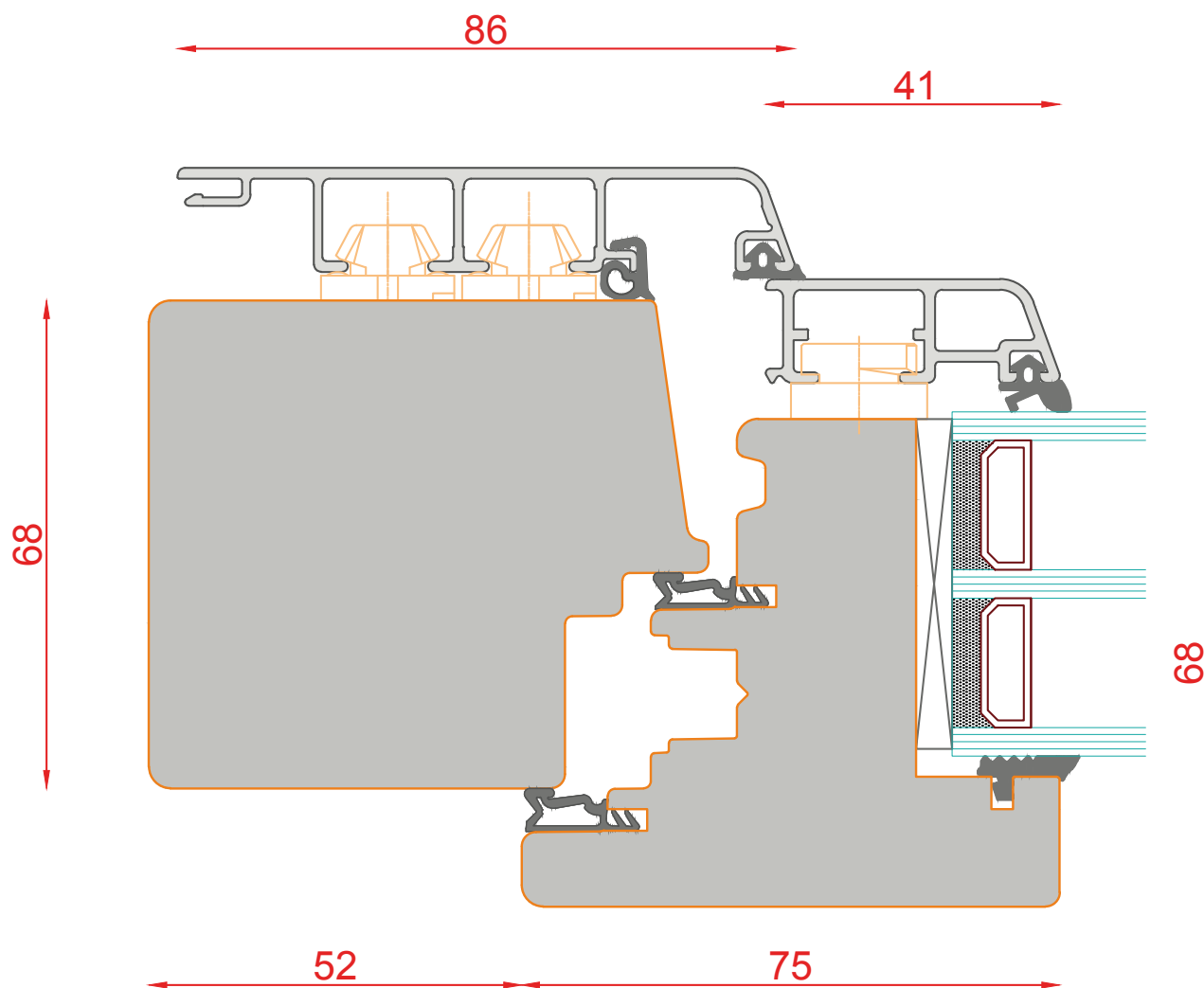
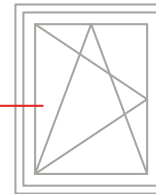

DUO 86

Schnitt : Horizontal seitlich und oben

Typ: DK

| Seite: 112

**SCHMIDT VISBEK**  
Fenster · Türen · Innenelemente

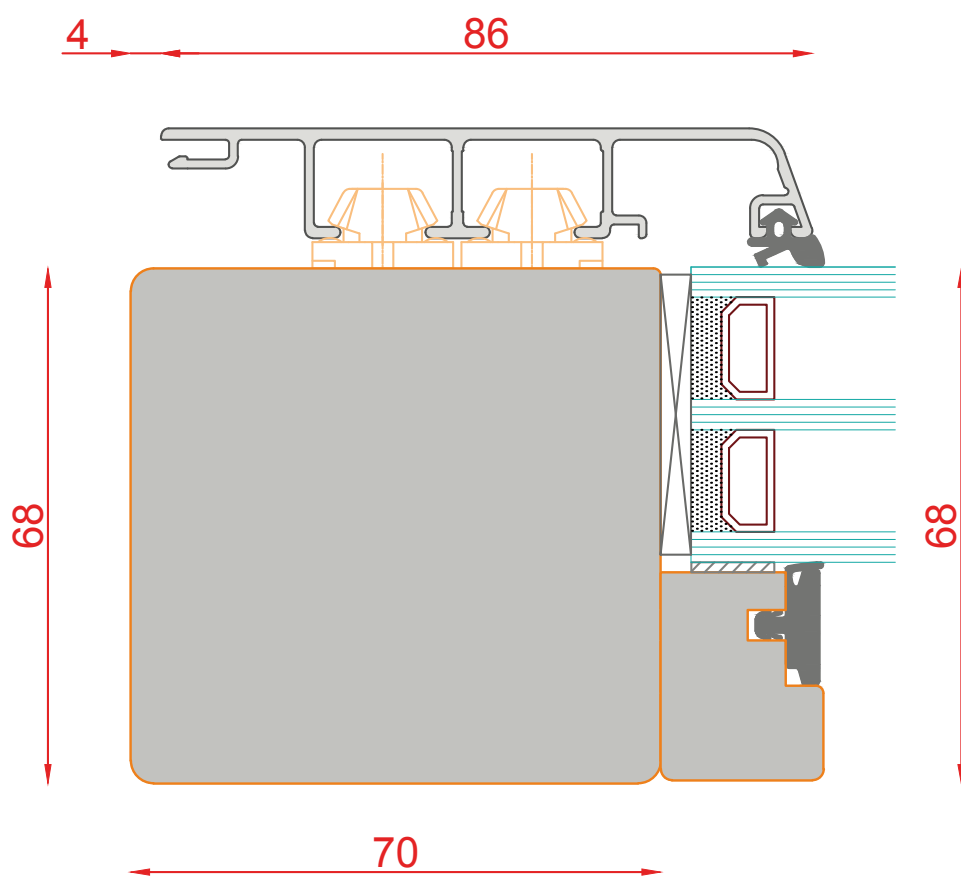
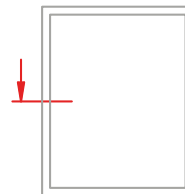

DUO 86

Schnitt : Horizontal seitlich und oben

Typ: FiB

| Seite: 113

**SCHMIDT VISBEK**  
Fenster Türen Innenelemente

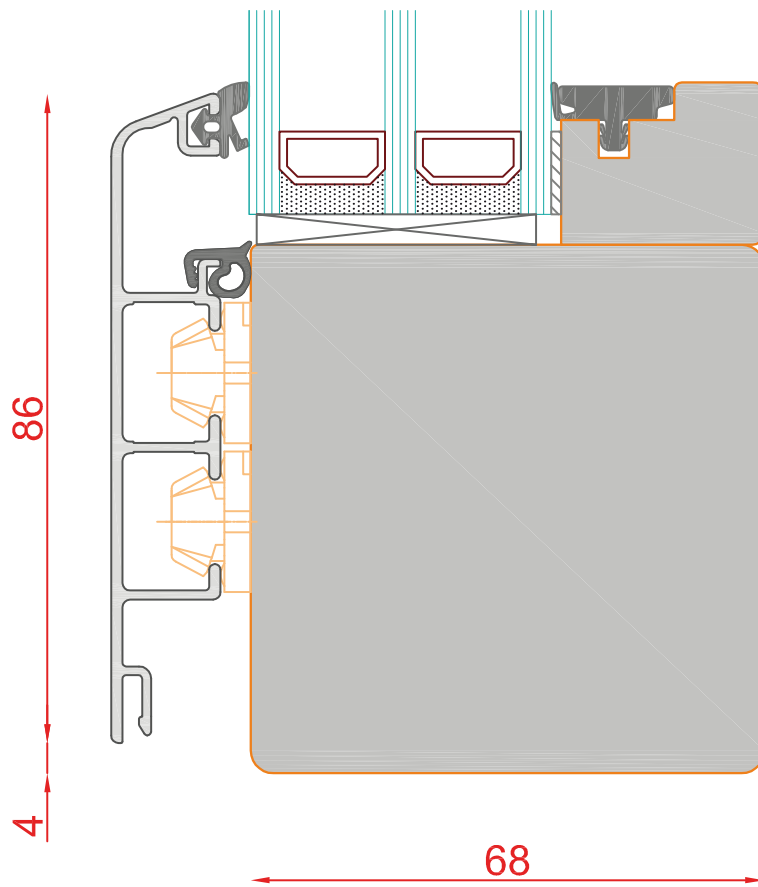
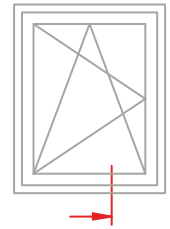

DUO 86

Schnitt : Vertikal unten

Typ: FIB

| Seite: 114

**SCHMIDT VISBEK**  
Fenster. Türen. Innovationen.

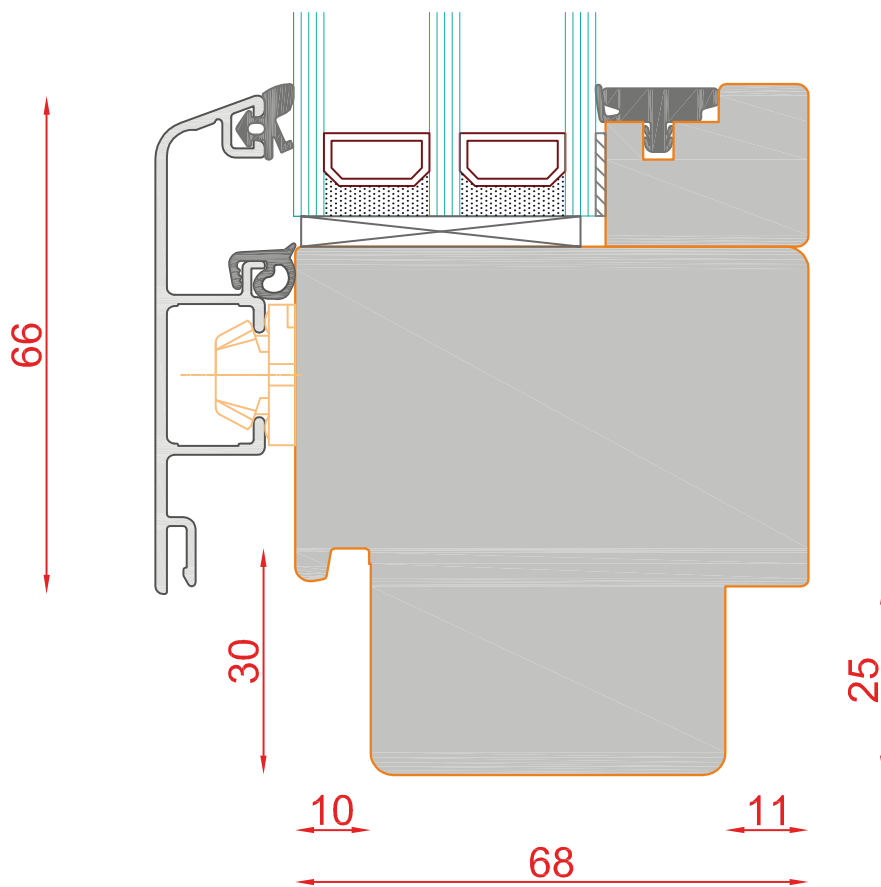
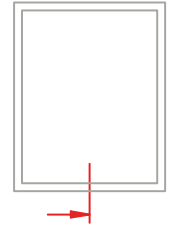

DUO 86

Schnitt : Vertikal unten

Typ: FiB

| Seite: 115

**SCHMIDT VISBEK**  
Fenster. Türen. Innovationen.



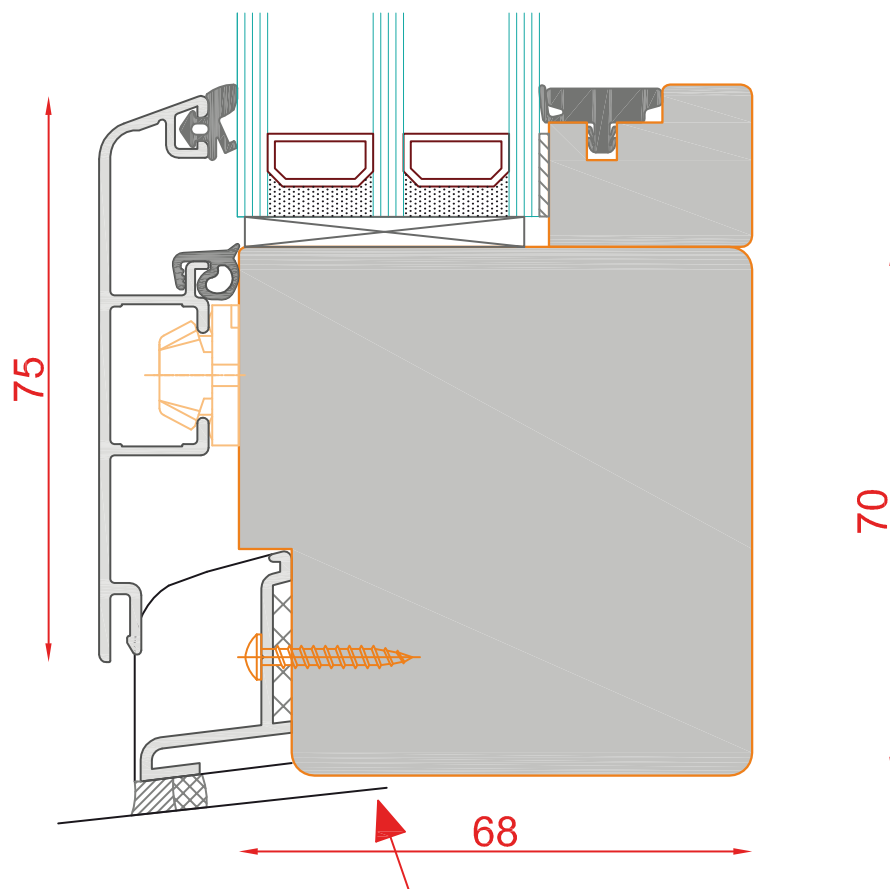
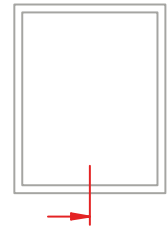

Befestigung Steinbankanschluss optional:

- sichtbar mit Schraube
- oder angeklebt
- mit Endkappen



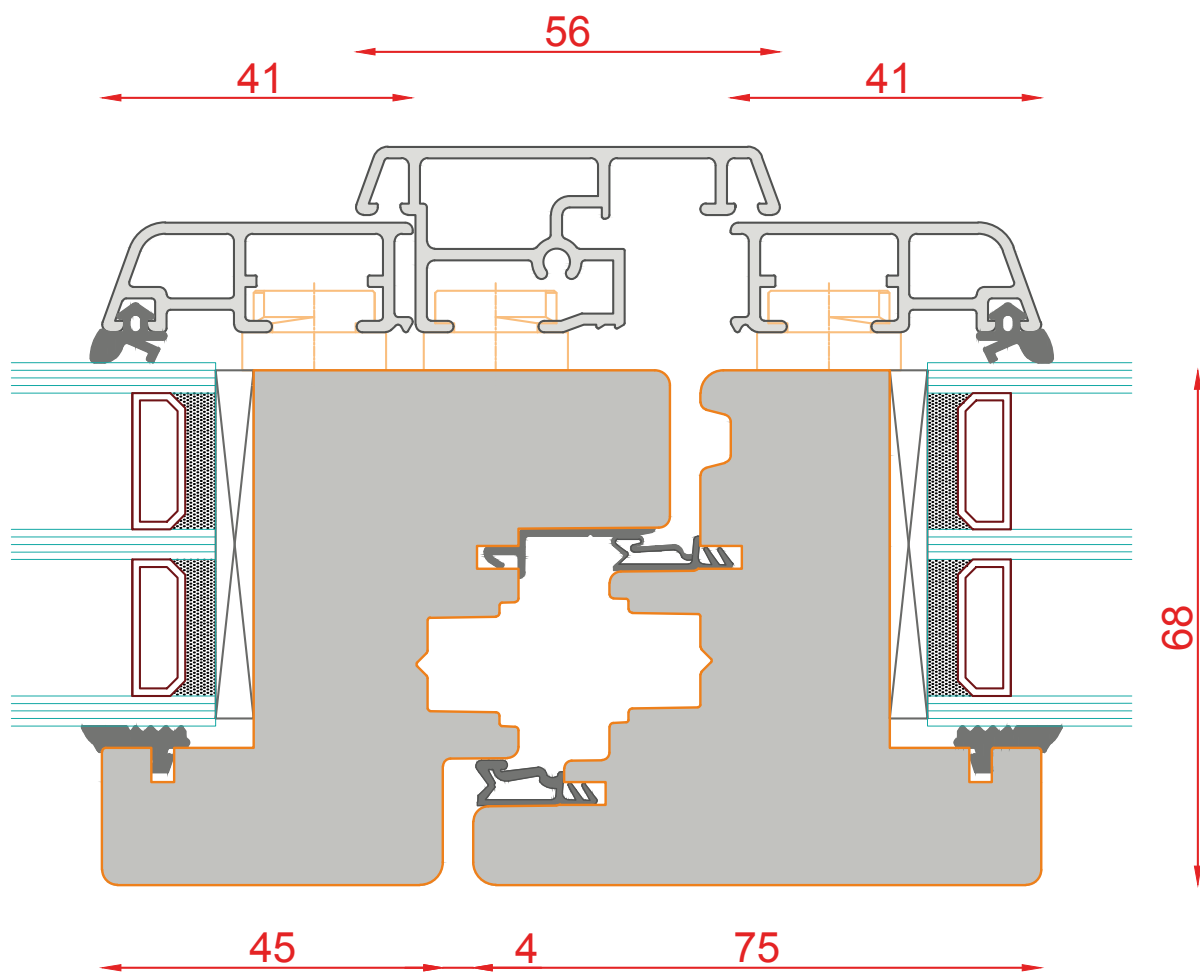
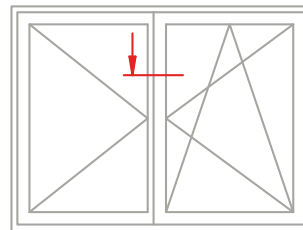

DUO 86

Schnitt : Horizontal Stulp

Typ: DK

| Seite: 117

**SCHMIDT VISBEK**

Fenster, Türen, Innenelemente.

110

41

68

75

34

75

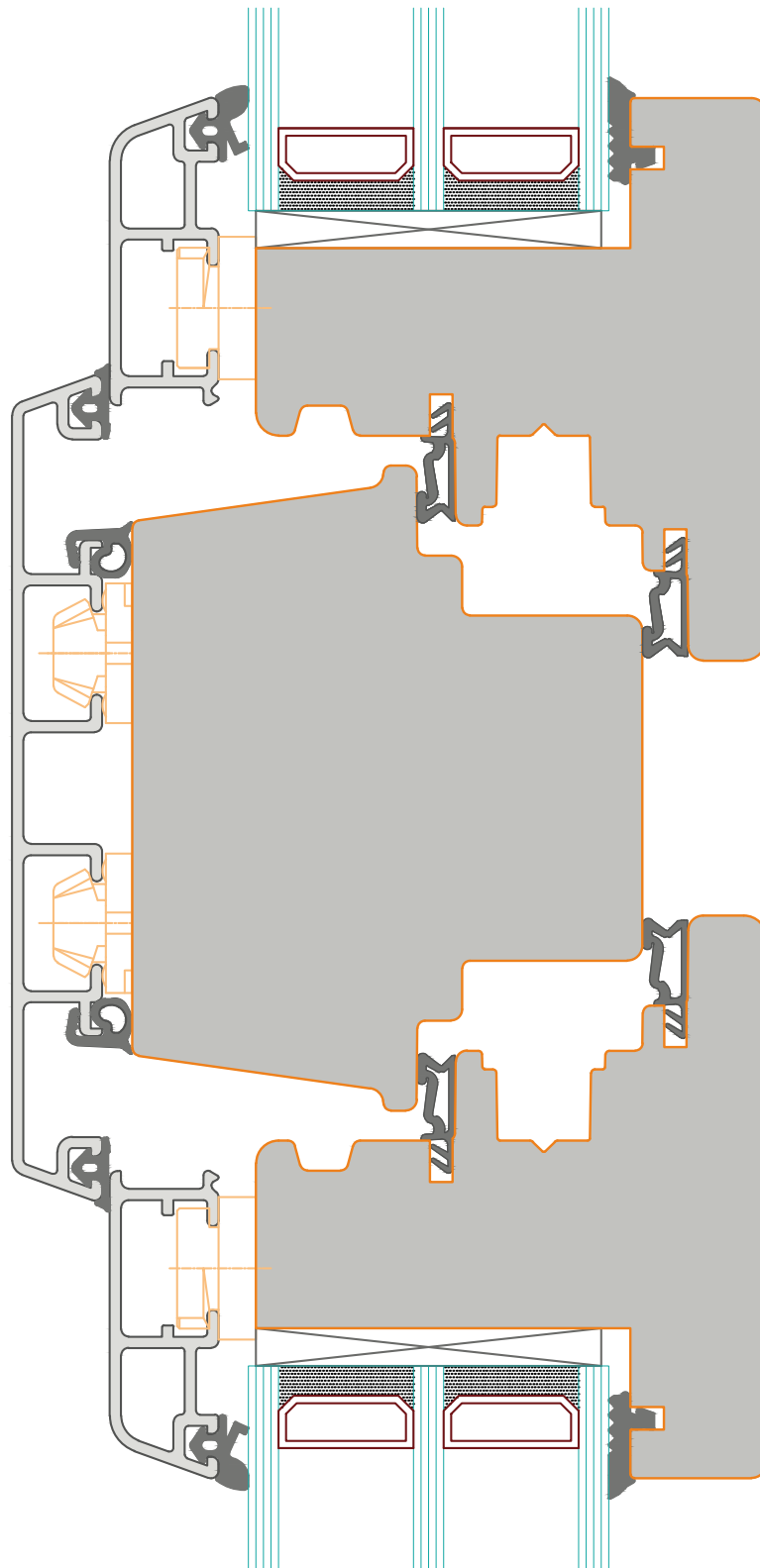
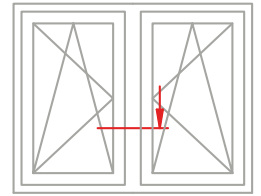

DUO 86

Schnitt : Horizontal Mitte Pfosten

Typ: DK mit Mittelpfosten

| Seite: 118

**SCHMIDT VISBEK**

Fenster · Türen · Innenrollläden



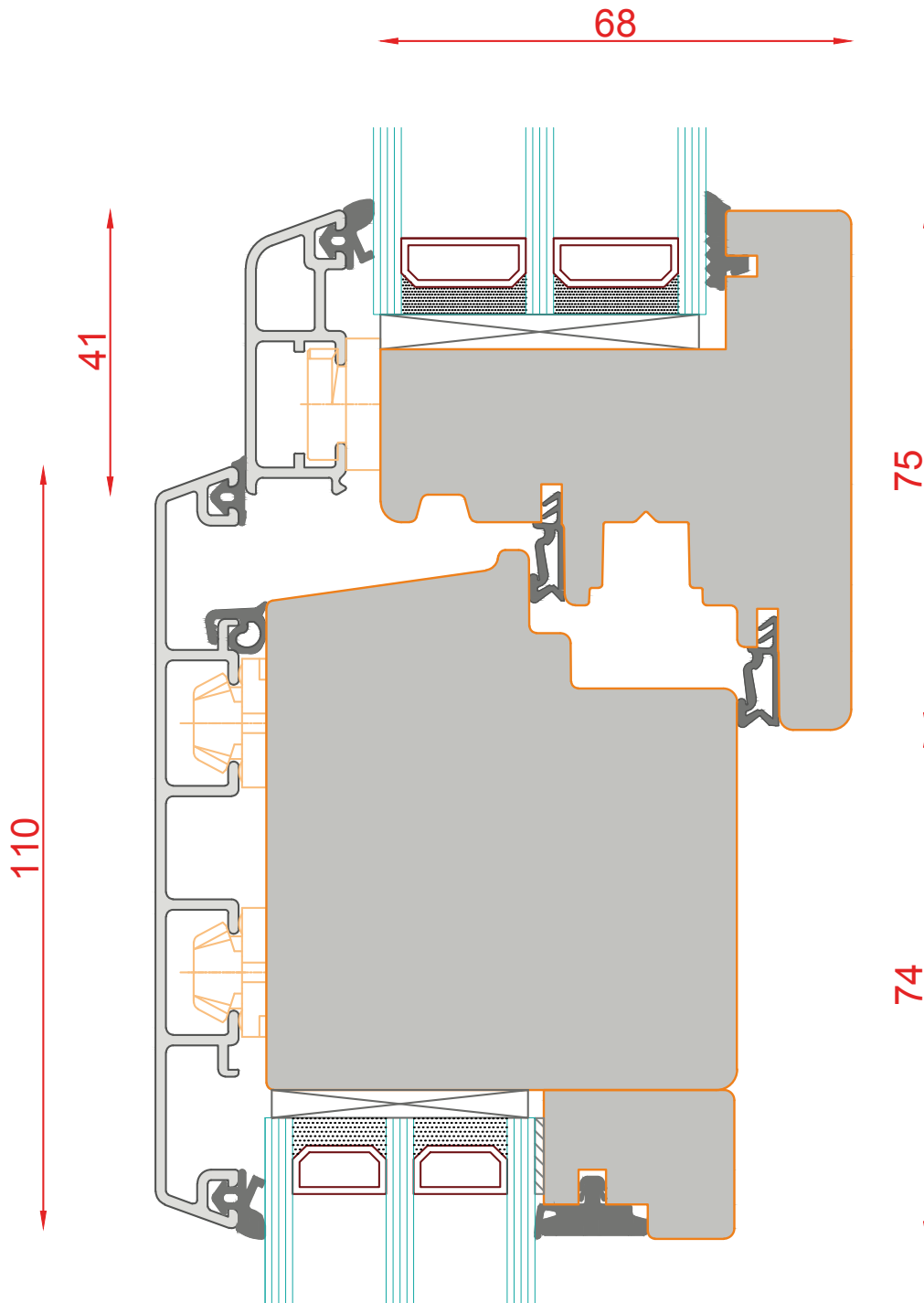
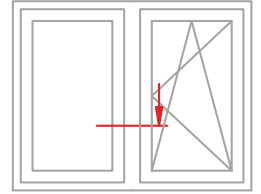

DUO 86

Schnitt : Horizontal Mitte

Typ: DK - FIB

| Seite: 119

**SCHMIDT VISBEK**  
FENSTER. TÜREN. INNOVATIONEN.

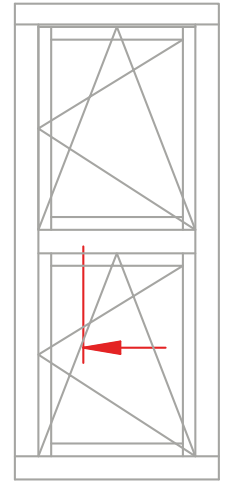
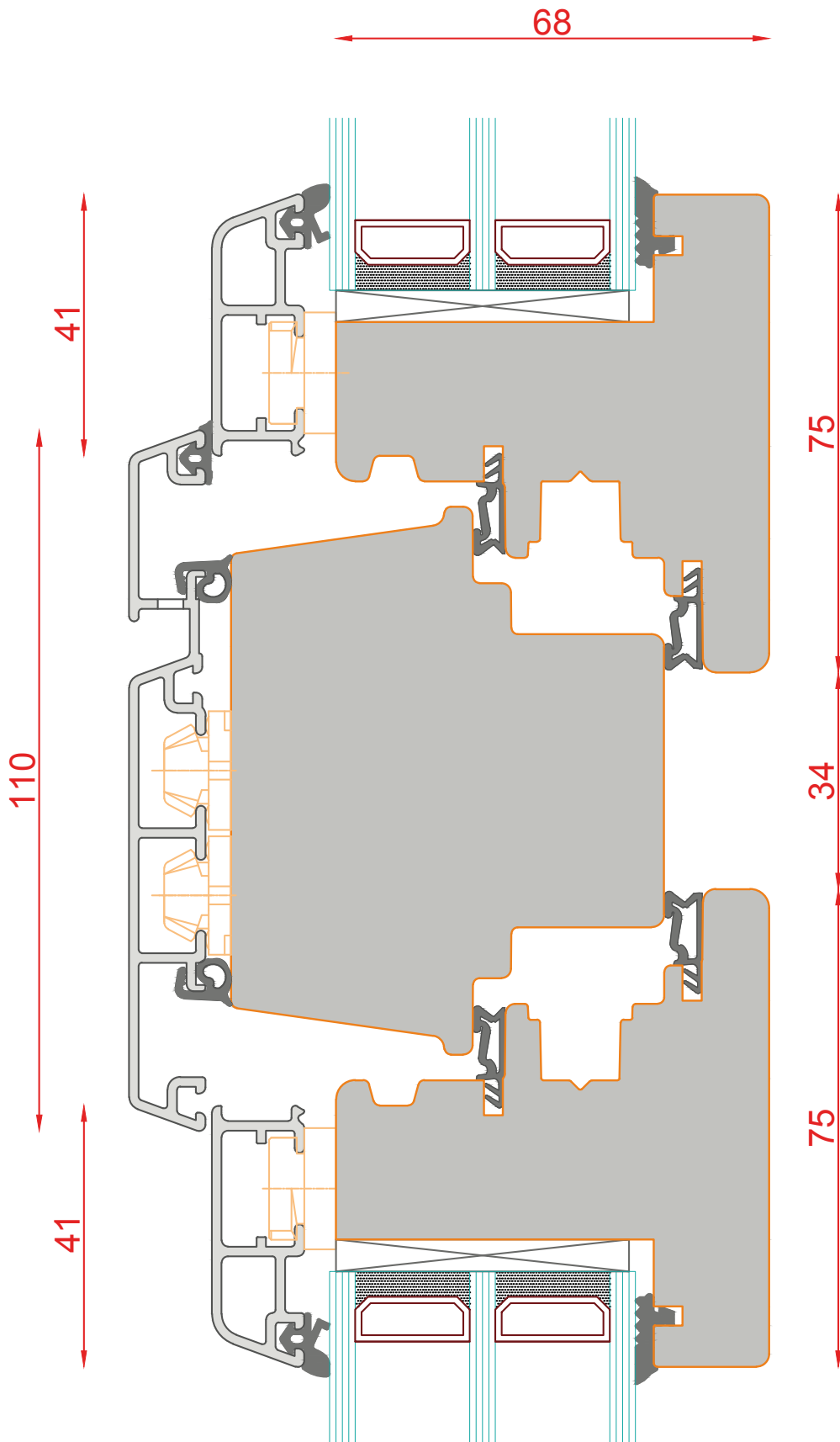

DUO 86

Schnitt : Vertikal

Typ: Kämpfer DK - DK

| Seite: 120

**SCHMIDT VISBEK**

Fenster, Türen, Innenelemente.

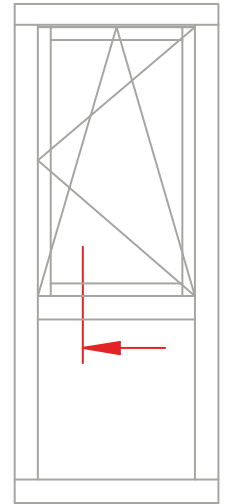
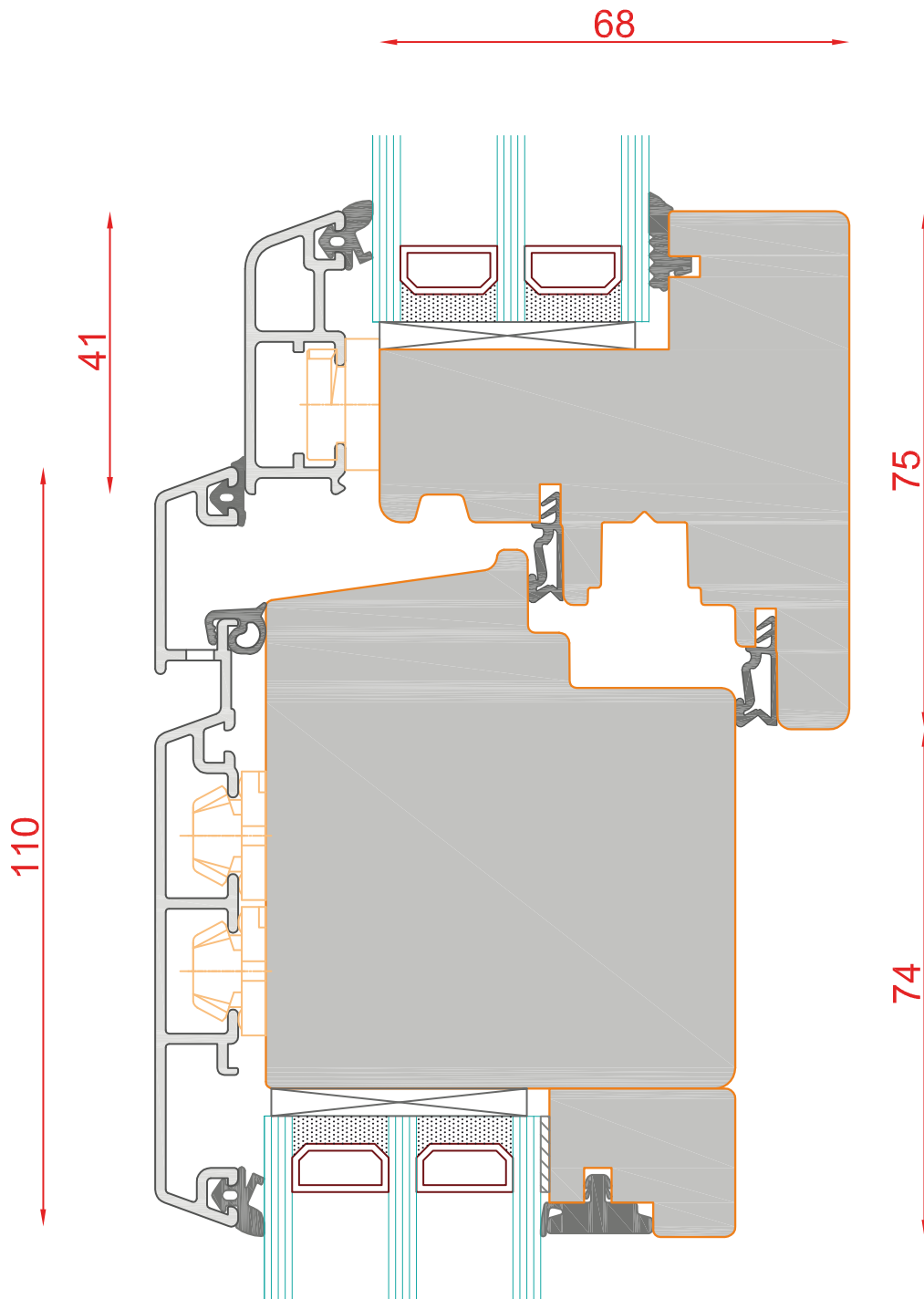

DUO 86

Schnitt : Vertikal Kämpfer DK-FIB

Typ: FiB

| Seite: 121

**SCHMIDT VISBEK**  
Fenster. Türen. Innovationen.

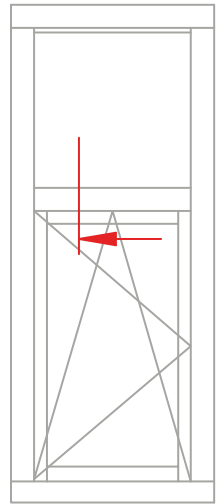
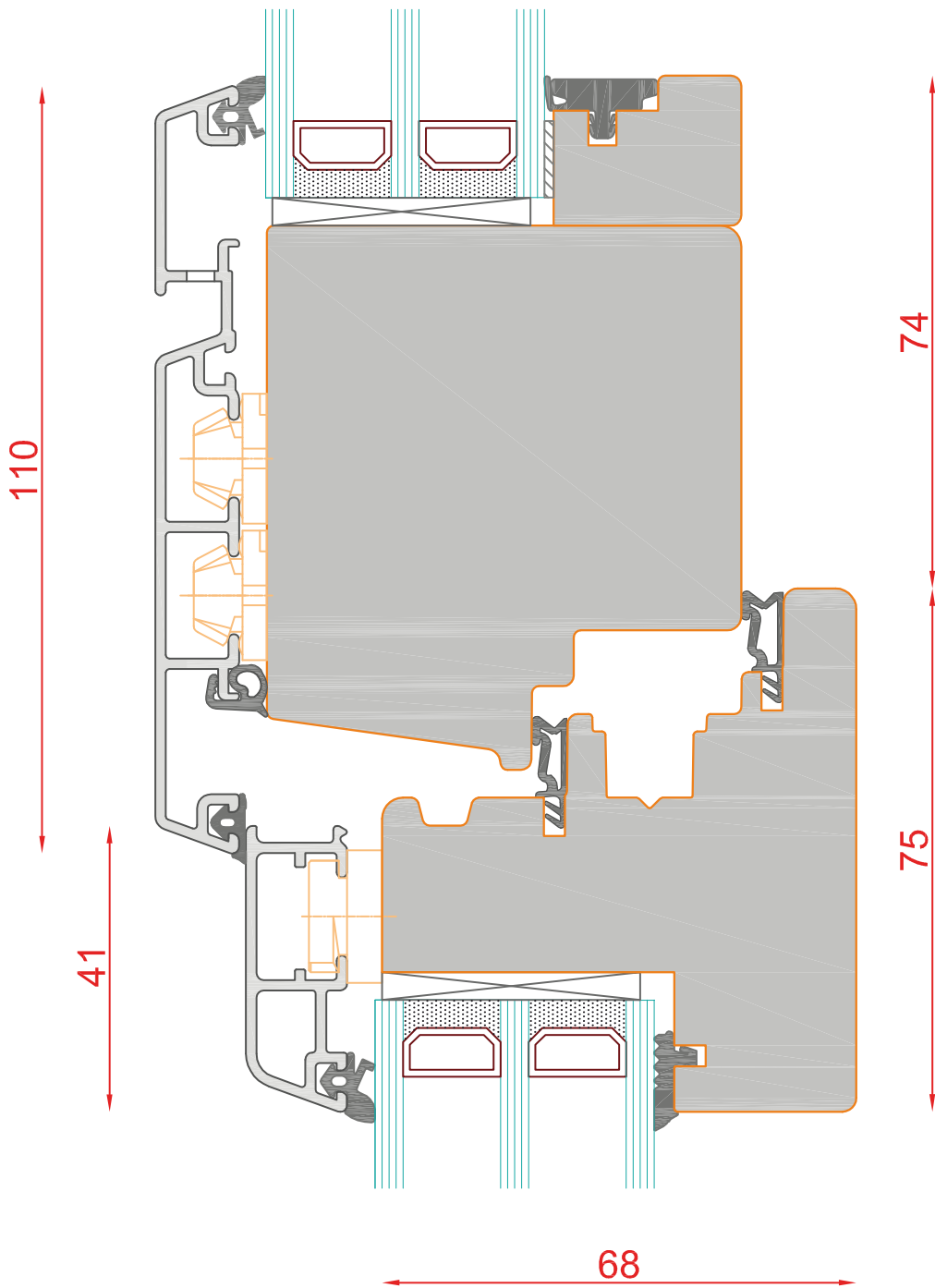

DUO 86

Schnitt : Vertikal Kämpfer DK-FIB

Typ: FiB

| Seite: 122

**SCHMIDT VISBEK**  
Fenster. Türen. Innovationen.

110

41

68

75

74

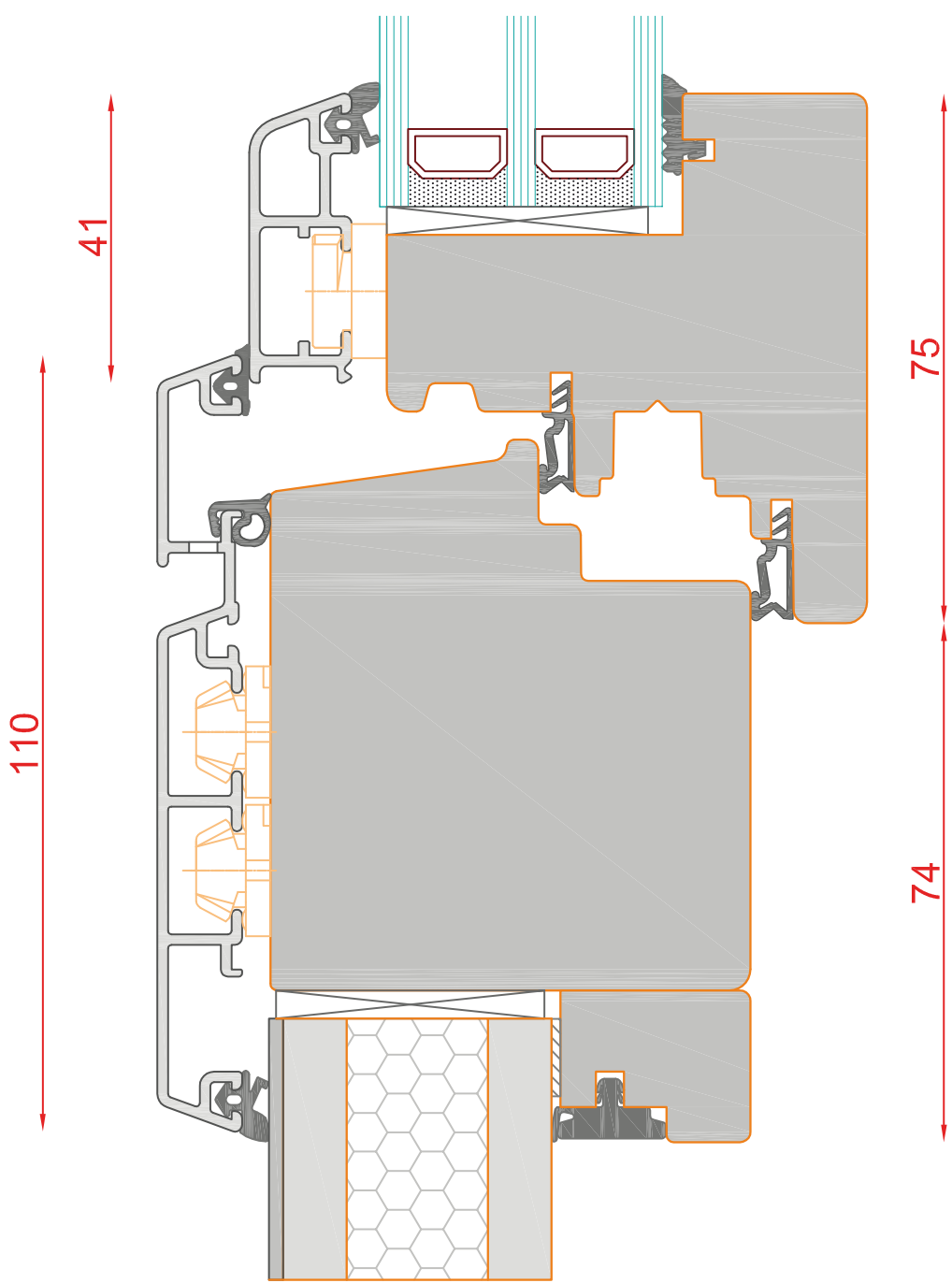
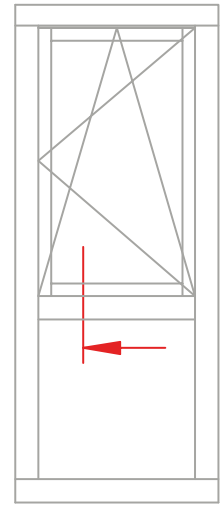

DUO 86

Schnitt : Vertikal Kämpfer DK-FIB

Typ: Füllung

| Seite: 123

**SCHMIDT VISBEK**  
 Fenster. Türen. Innovationen.



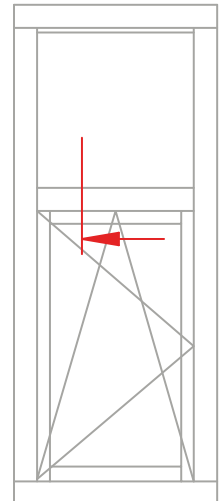
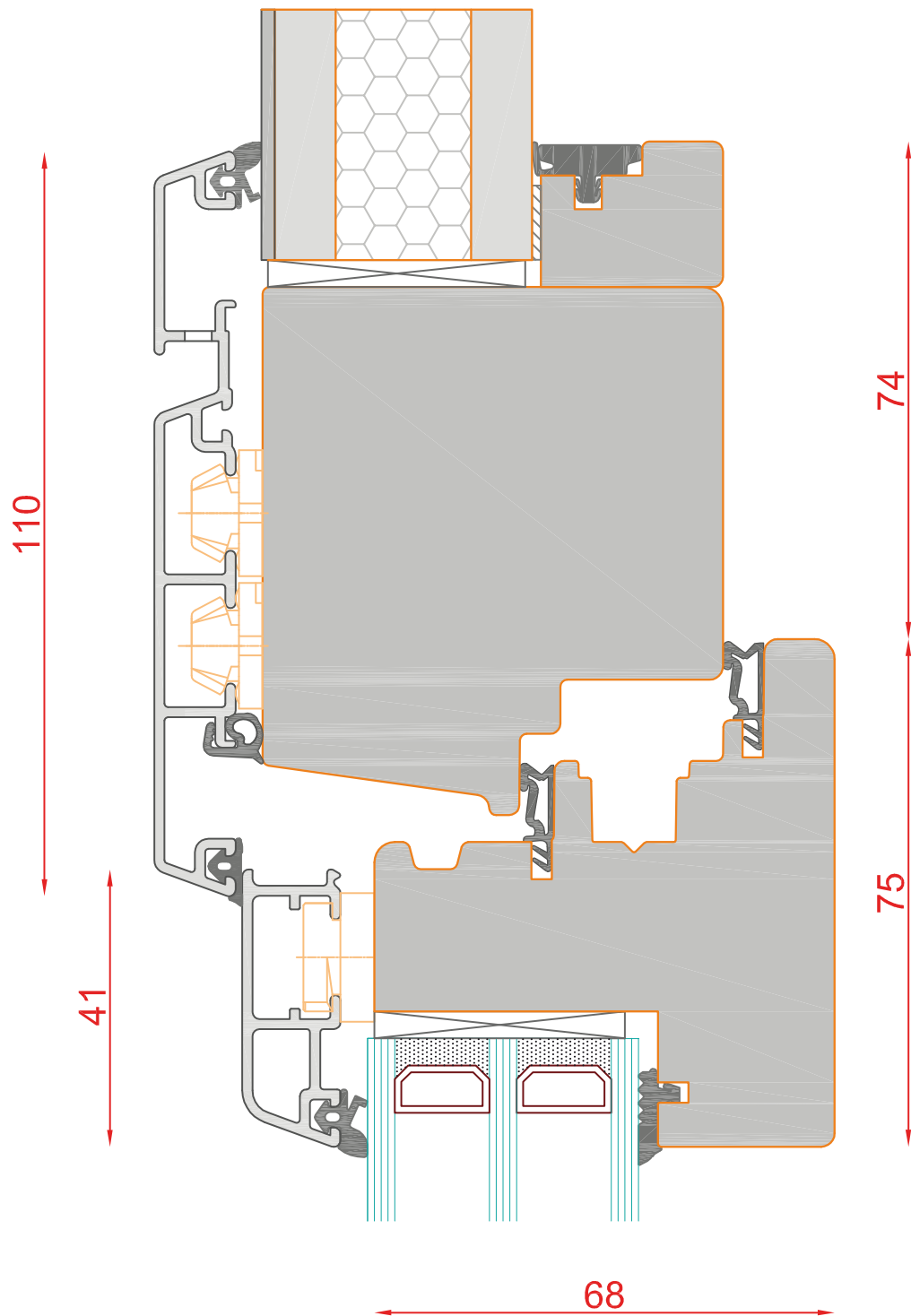

DUO 86

Schnitt : Vertikal Kämpfer DK-FIB

Typ: Füllung

| Seite: 124

**SCHMIDT VISBEK**  
Fenster. Türen. Innovationen.

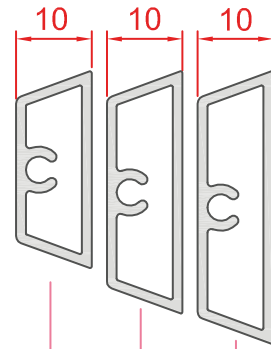

SP 36.10 = 36mm  
 SP 32.10 = 32mm  
 SP 26.10 = 26mm

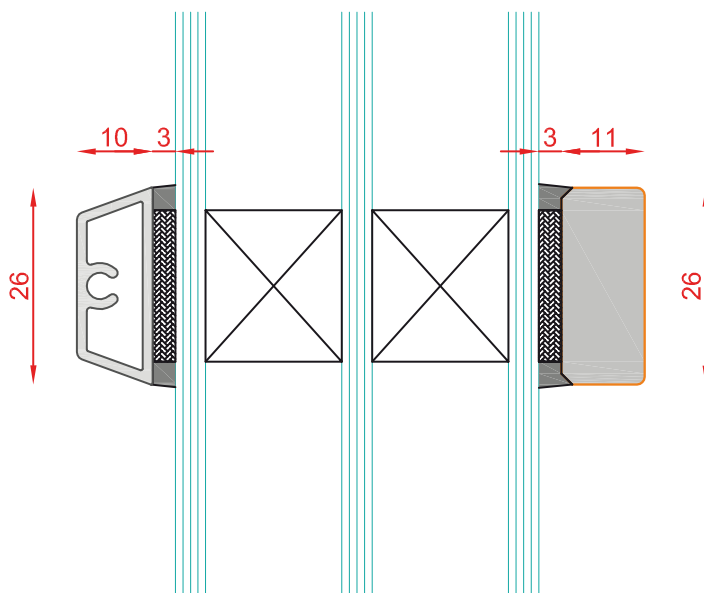
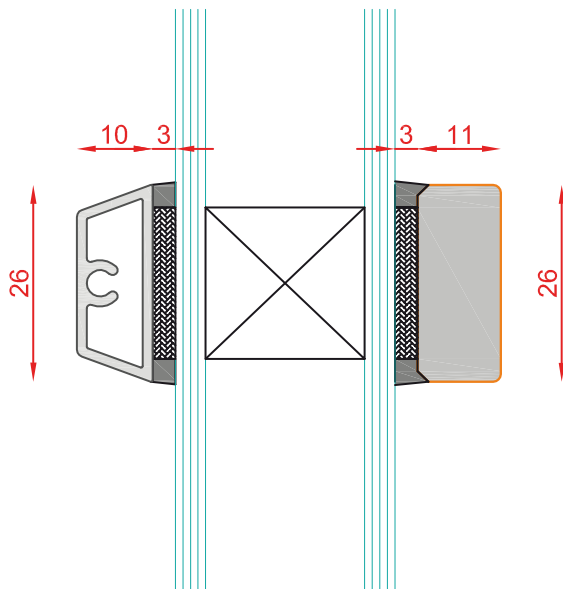

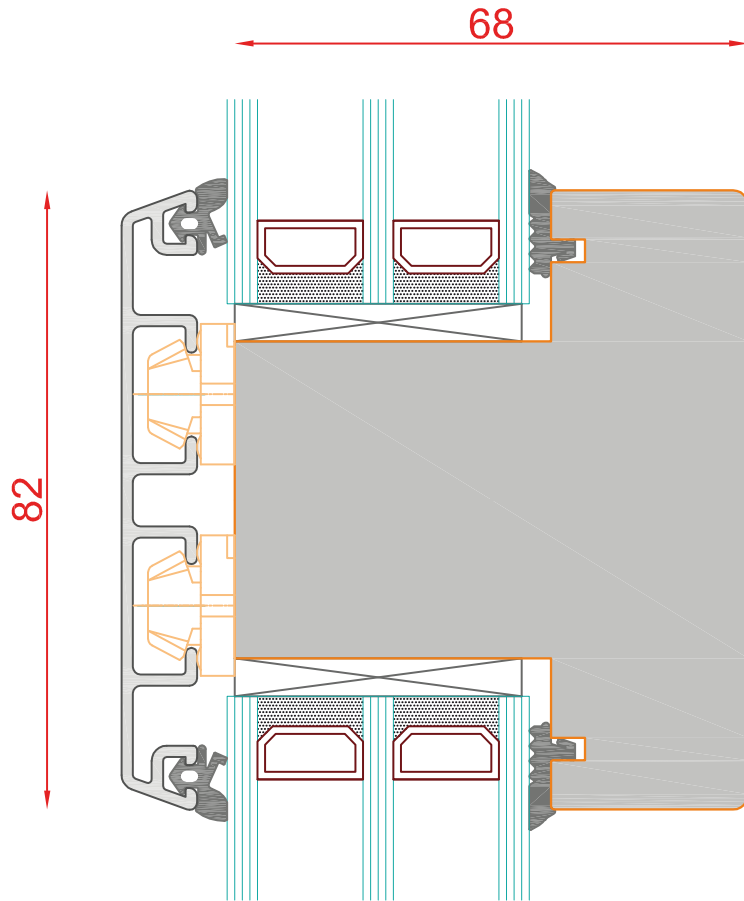
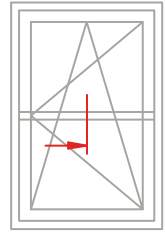

DUO 86

Schnitt : Sprosse Glasteilend

Typ: Flügel

| Seite: 126



**SCHMIDT VISBEK**  
Fenster. Türen. Innovationen.

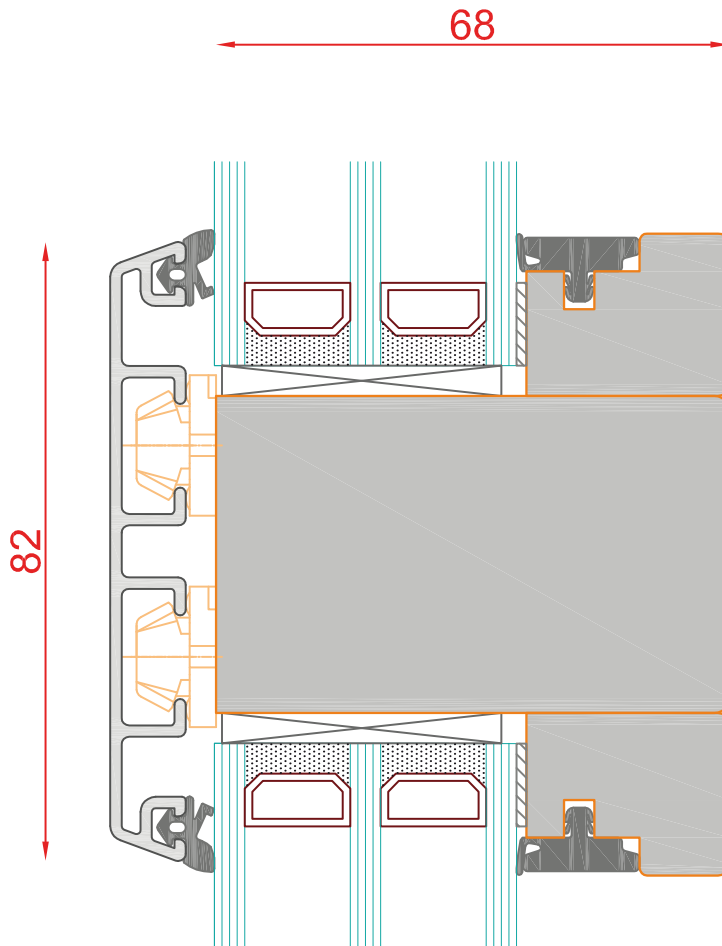
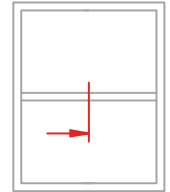

DUO 86

Schnitt : Sprosse Glasteilend

Typ: Blendrahmen

| Seite: 127

**SCHMIDT VISBEK**  
Fenster. Türen. Innovationen.

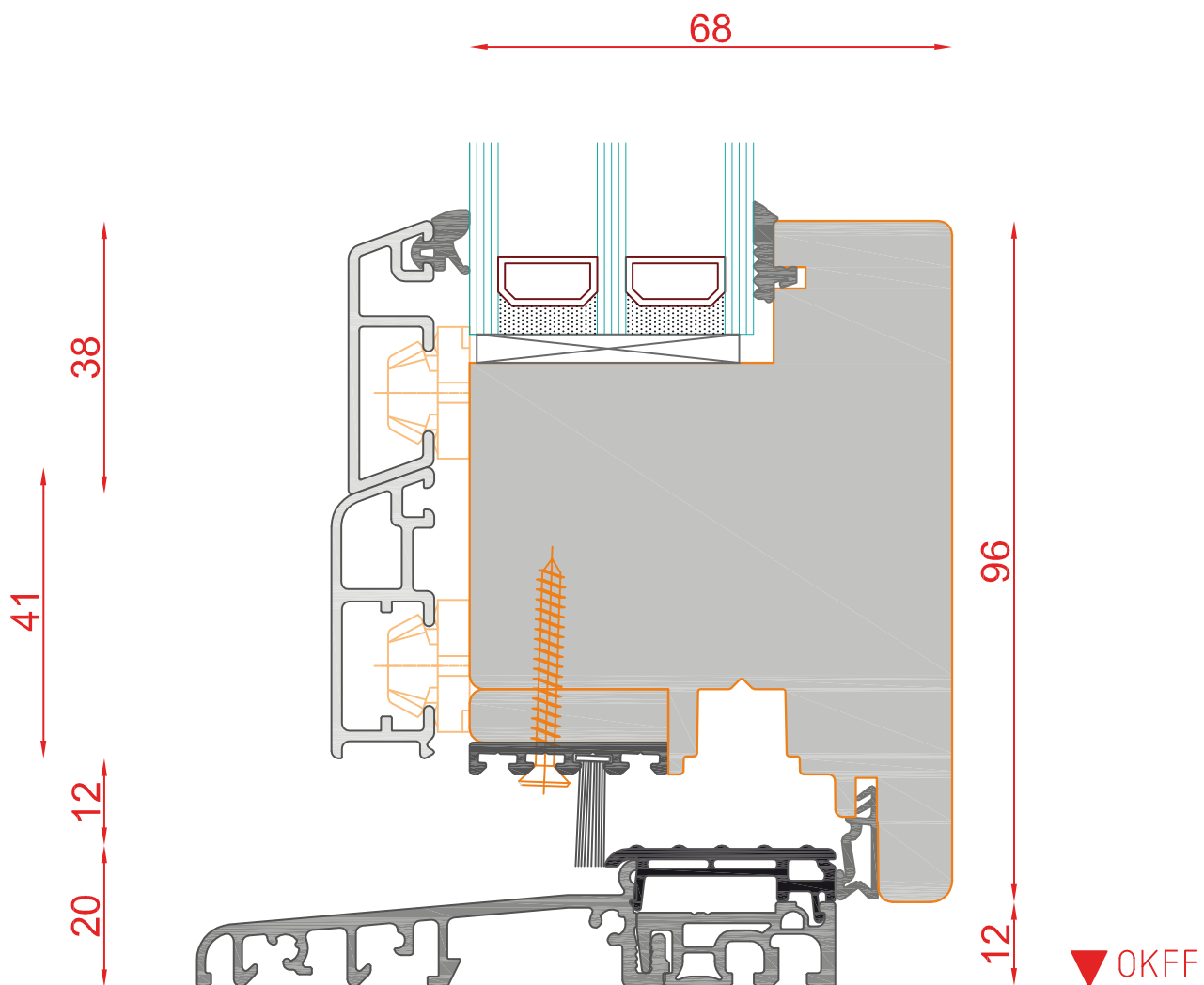
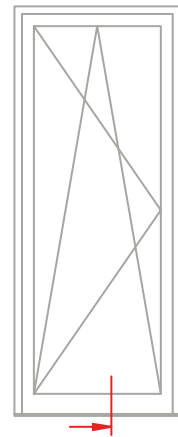

**Bodenschwelle BKV Eifel 90 TB**



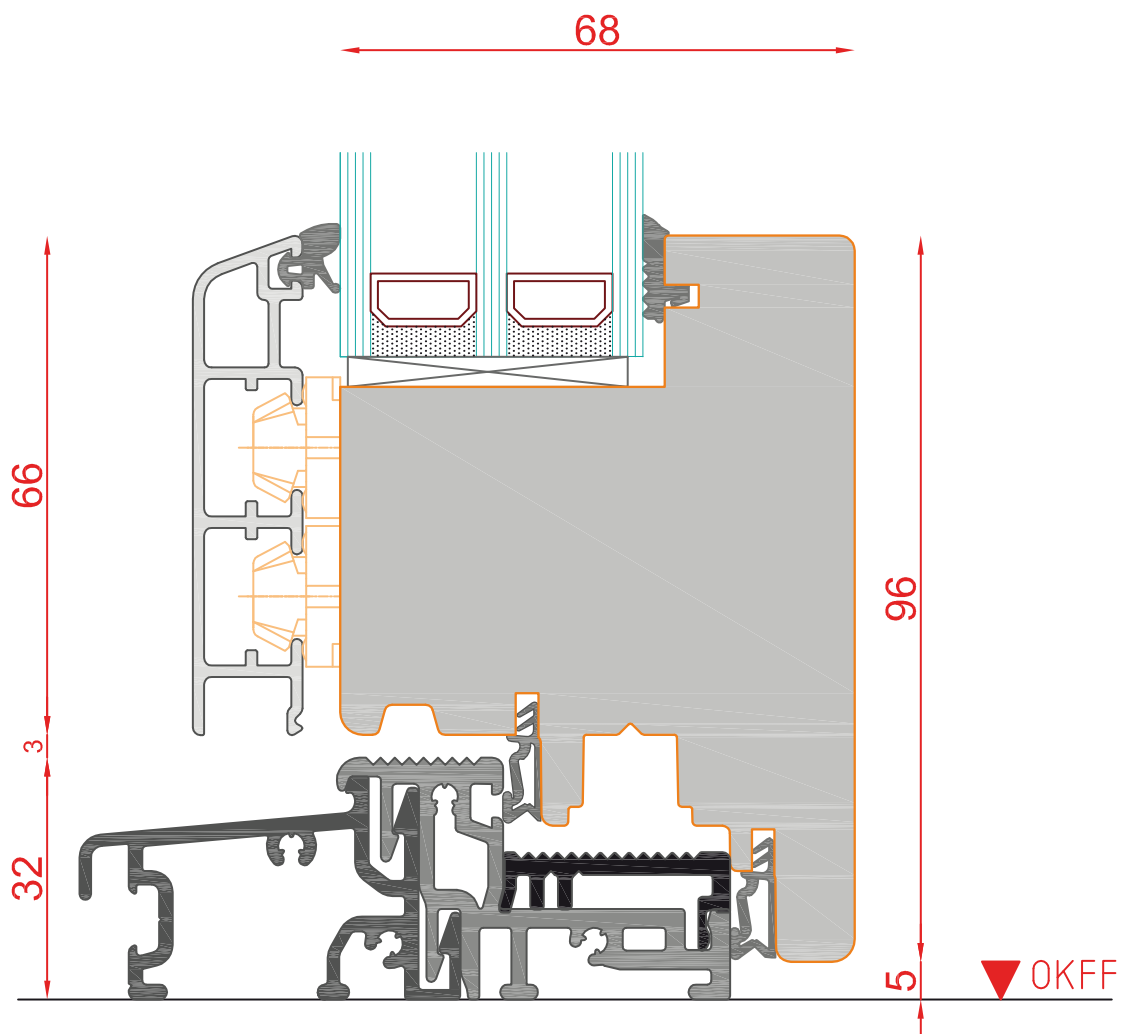
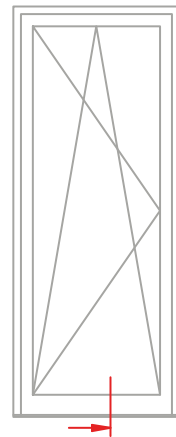

Bodenschwelle Weser 86/32 Ti



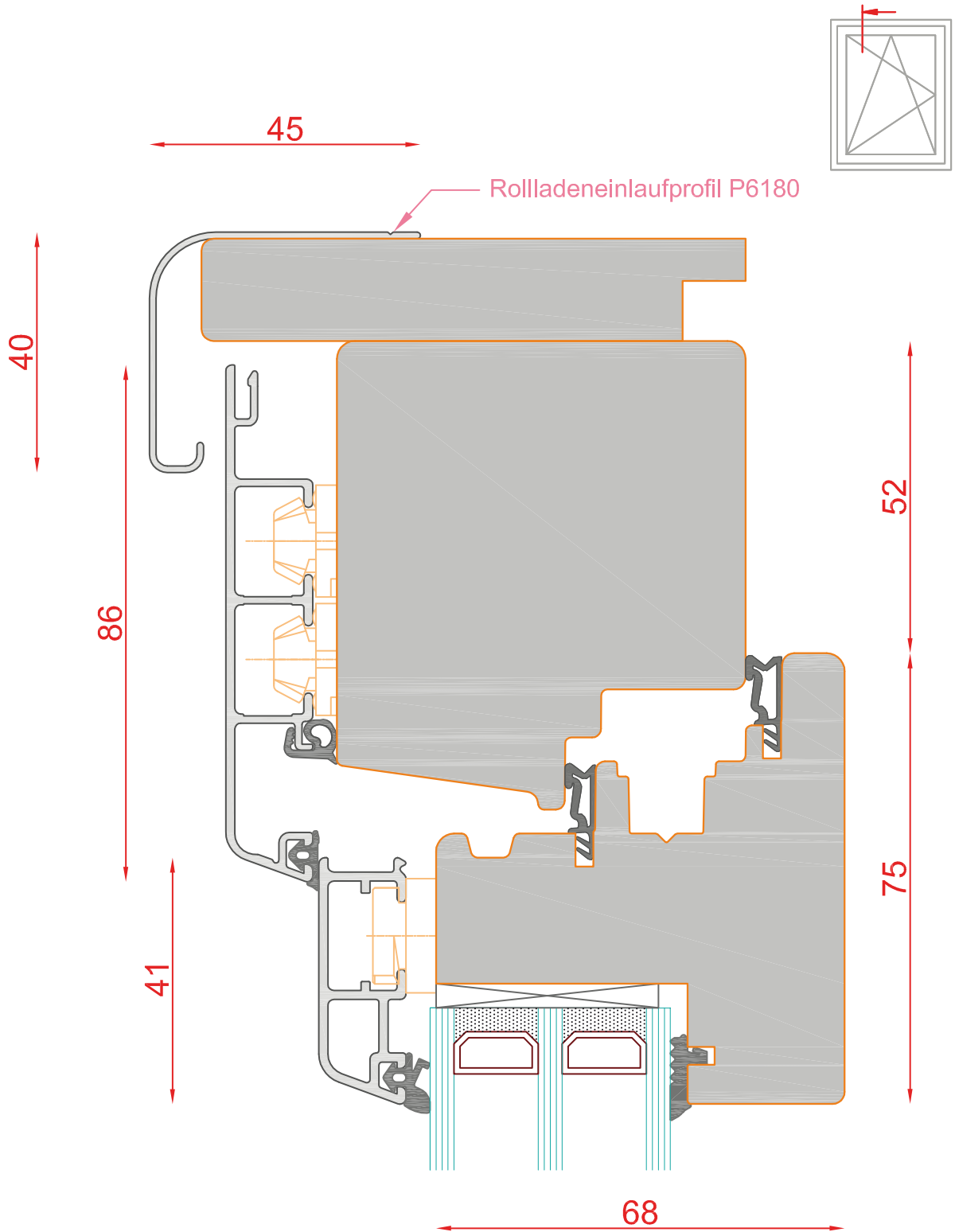

DUO 86

Schnitt : Horizontal seitlich und oben

Typ: DK

| Seite: 130

**SCHMIDT VISBEK**  
Fenster. Türen. Innovationen.



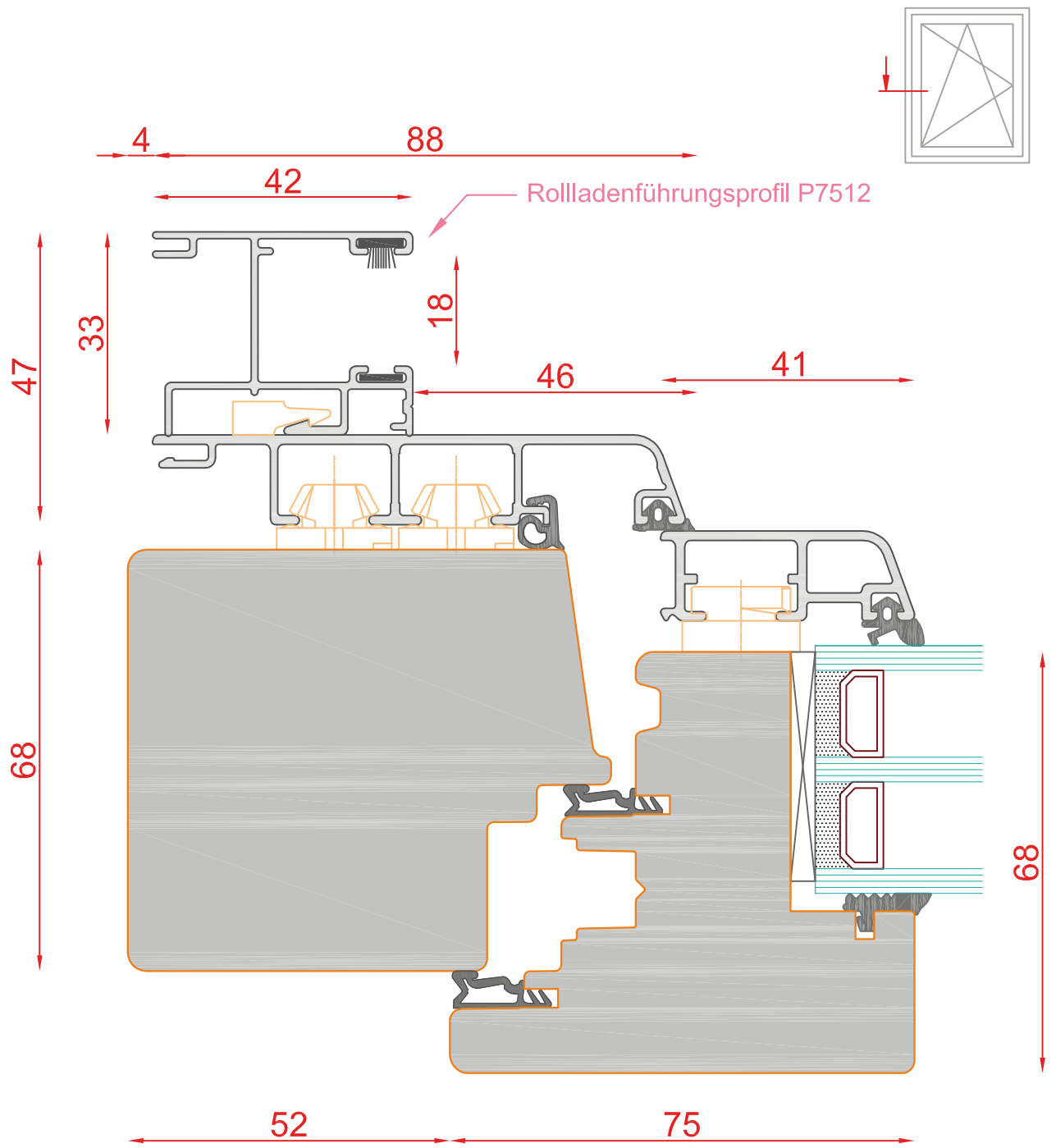

DUO 86

Schnitt : Horizontal seitlich und oben

Typ: DK

| Seite: 131

**SCHMIDT VISBEK**  
Fenster. Türen. Innovationen.



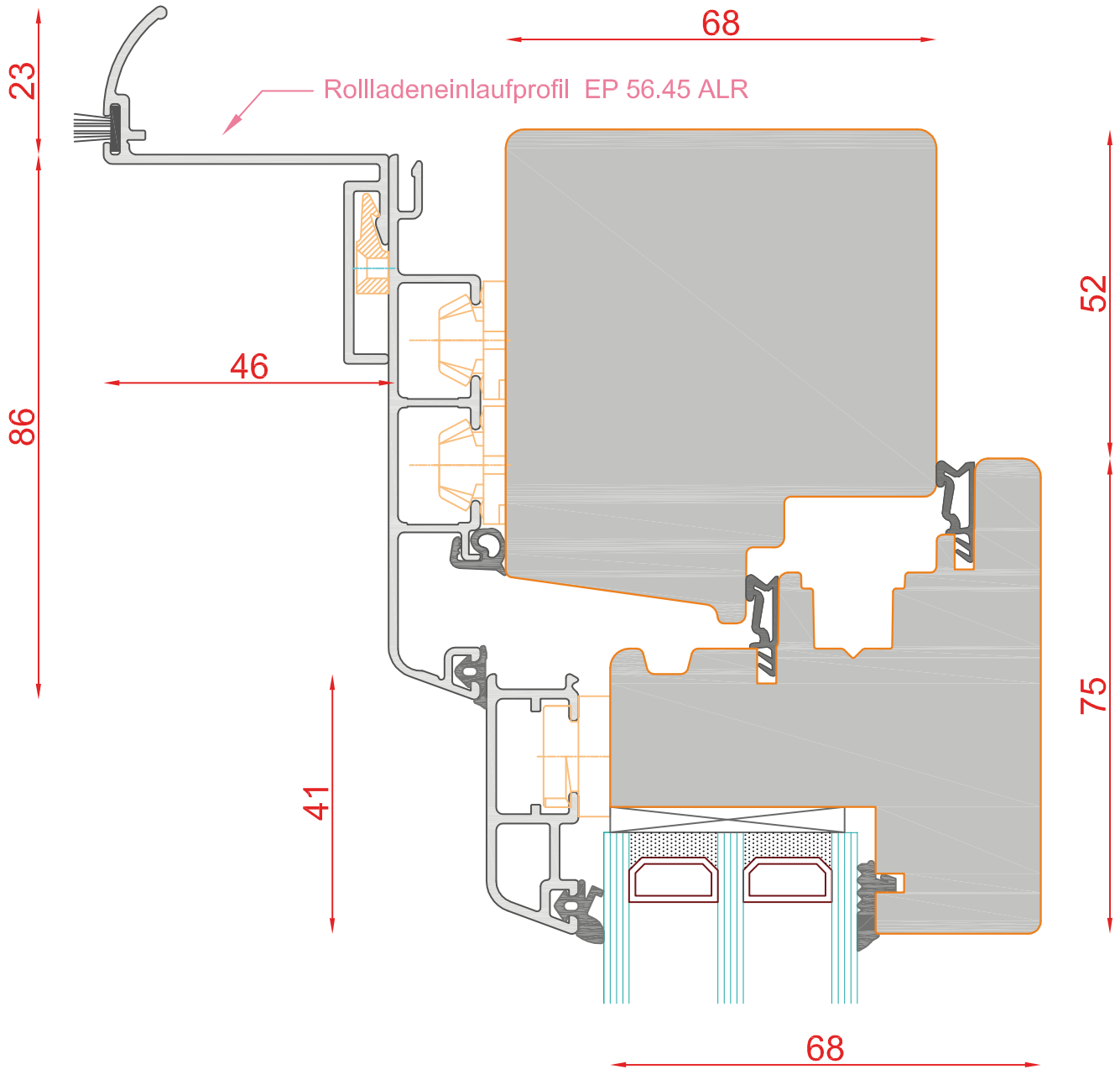
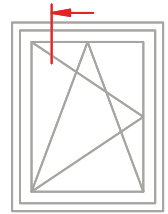

DUO 86

Schnitt : Horizontal seitlich und oben

Typ: DK

| Seite: 132

**SCHMIDT VISBEK**  
Fenster. Türen. Innovationen.

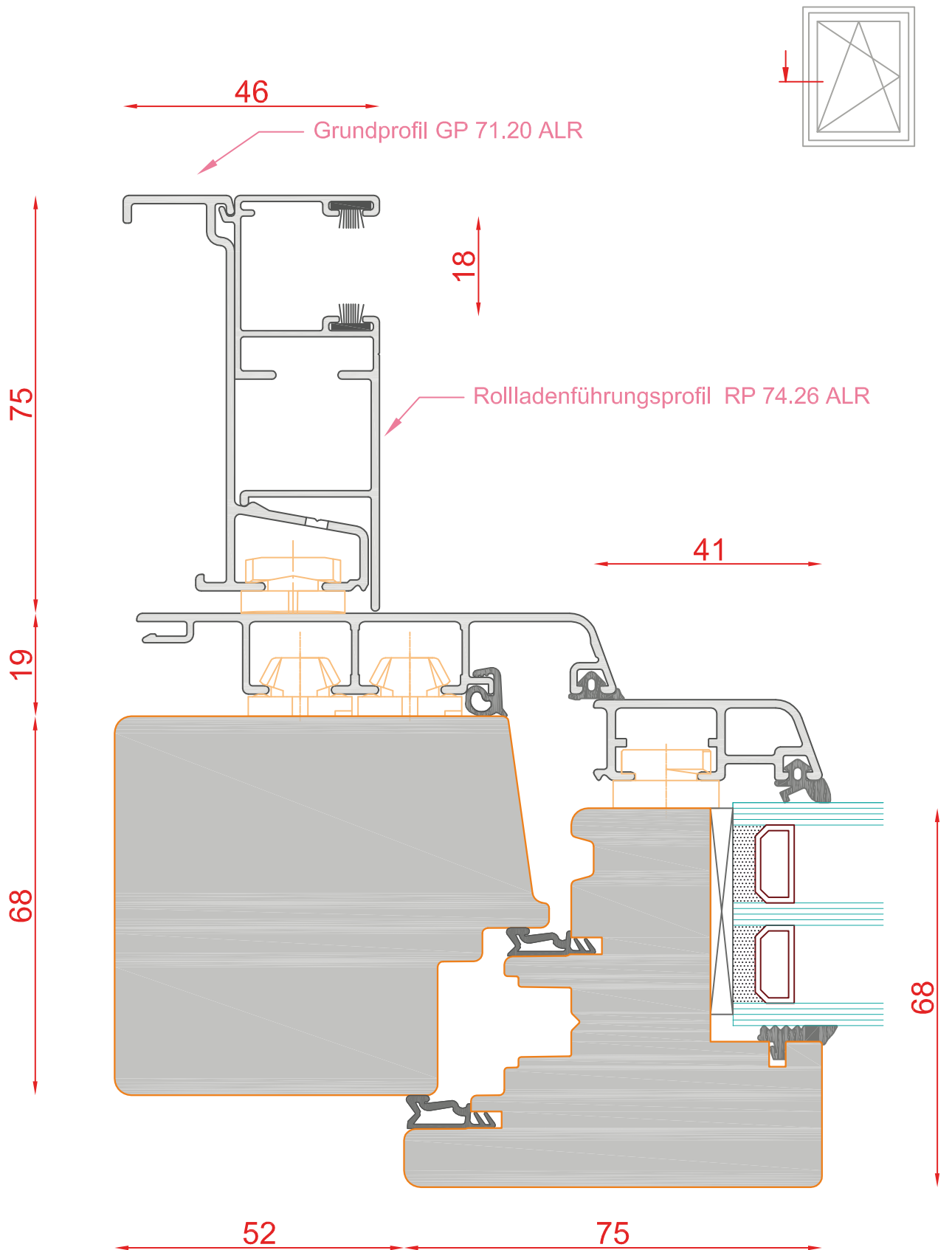

DUO 86

Schnitt : Horizontal seitlich und oben

Typ: DK

| Seite: 133

**SCHMIDT VISBEK**  
Fenster. Türen. Innovationen.